



*Excellence in  
production line  
automation*



**Jenton Group**



# CONTENTS

JentonAriana .....	3
Packleader BCS Convergents / In-Liners .....	4
FCS & FCS 2 High Speed Pack Collator-Stacker .....	6
Automatic Seal Tester & Converger .....	8
Automatic Pad Placers .....	10
JenAct .....	12
GRU-V Air Purifier Cool / Food .....	13
UV Torpedo Conveyor .....	14
Pulsed UV Mushroom Conveyor .....	15
JentonDimaco .....	16
Veri-CENTRAL .....	17
Veri-PACK .....	18
Veri-WEIGH .....	20



# JENTON ARIANA

Specialists in food packaging automation including convergers, seal testers, stackers, UV disinfection and label & data verification.

Ariana became part of the Jenton Group in 2005 and now products can be integrated with the UV disinfection equipment from JenAct and label and data verification vision systems from Jenton Dimaco.

Jenton Ariana offers bespoke design possibilities, whether customers are retail, manufacturing or production orientated. Our design team is always ready to discuss your application. All our products started life as a solution to someone's problem.

As an ISO 9001 company we keep a full record of the equipment we supply, meaning machines can be fully refurbished and brought up to the latest technical specifications. All machines are designed and manufactured at our facilities in Hampshire, England to the highest professional standards using stainless steel and other food grade materials.

Jenton Group products have been exported for more than 10 years, and are available to suit different standards and voltages with HMIs shipped in over 10 languages so far.



*Food packaging automation including convergers, seal testers, stackers, UV disinfection and label & data verification*



# PACKLEADER BCS CONVERGERS / IN-LINERS



*Converge  
multi-lane  
production into  
a single lane*

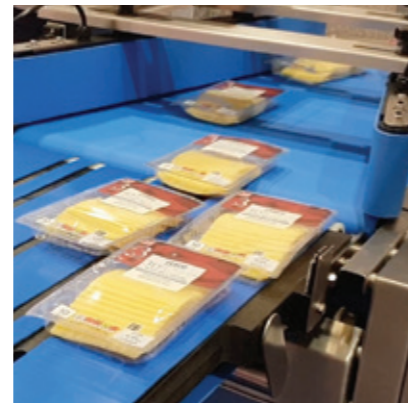

The Packleader BCS range of high speed convergers is designed to take multi-lane production of thermoformed packs and converge them at accurate spacing into a single lane.

BCS convergers are simple to use, set up and most importantly clean and maintain. Belts can easily be removed and are self tracking.

Powered converging belts and direct replacement of thermoformer exit conveyors allow shortest possible footprints. The latest B&R advanced control technology helps set-up and communication to line controls.

Automatic converging is now an affordable option for users of smaller thermoformers and those with limited space. The BCS converger is suitable for almost all pack sizes, types, speeds and formats, wet or dry.



## FEATURES

- Colour touchscreen HMI (B&R)
- Menus for pack formats, belt speeds and pack gaps
- Store up to 9 pack format settings
- Remote operation capability
- Self tracking belts
- High Speed - up to 180 packs per minute



## ADVANTAGES

- Fast and simple belt change & cleaning minimizes downtime
- Quick access to motors and drives
- Industry standard components
- Easy washdown
- Up to IP67 protection

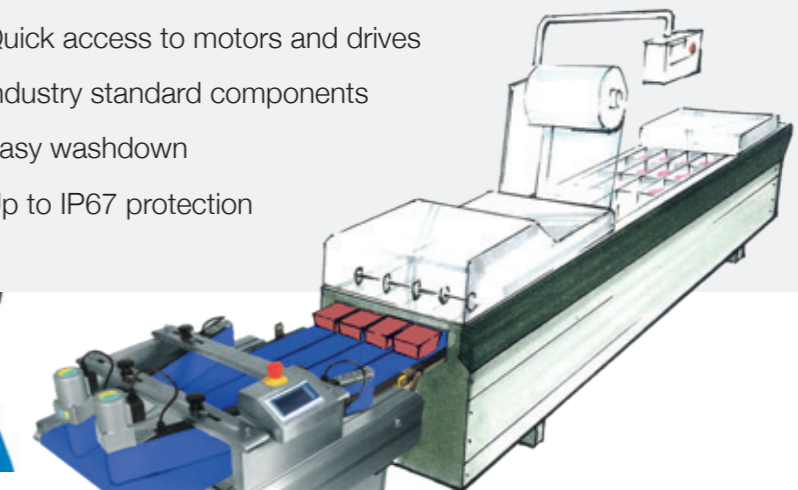
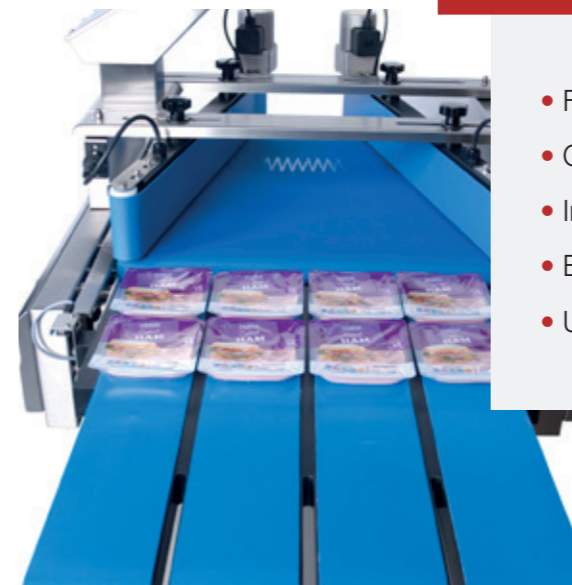

## BENEFITS

- Variable line height
- Integrates directly to thermoformers, checkweighers etc.
- Minimum addition to line length (1140mm)
- High speed controlled converging maximises performance of metal detector checkweighers etc.
- Multiple infeed belts for quick format-change



# FCS & FCS 2 HIGH SPEED PACK COLLATOR-STACKER



*The FCS range of stackers are versatile, simple to use and most importantly, tolerant of pack variability*

The fastest automatic stacker of its type, achieving speeds of up to 180 packs per minute.

The colour touch screen / HMI makes the machine very easy to set for a large variety of pack sizes and stack heights, and all settings can be sorted against a name.

The FCS & FCS 2 high speed stacker is the ideal solution for end-of-line high speed collation where minimal operator intervention and reliability are critical.



## FEATURES

- Colour touchscreen / HMI for simple setup and use
- Independent infeed and outfeed conveyor heights
- Self tracking belts
- All stainless steel construction
- Easy access



## ADVANTAGES

- High reliability stacking
- Continuous or batched outfeed
- Very quick setup
- Up to IP67 protection
- High speed - up to 180 packs per minute



## BENEFITS

- High speed stacking with minimal operator interaction
- Suitable for a very large range of pack sizes
- Continuous or pulsed outfeed belt for easy product handling





# AUTOMATIC SEAL TESTER & CONVERGER

The Jenton Ariana in-line seal tester is both fast and accurate.

The pressure plate based system can also be used as part of the production process to ensure accurate pack heights for final packaging. It is able to test packs from up to 15 thermoformer cycles per minute or 180 packs per minute from a tray sealer. Most importantly, it only rejects faulty packs NOT the whole format.

The seal tester tests gas flushed MAP/CAP packs for leak, over-gas and under-gas. 100% of packs are tested, the faulty packs are rejected into a separate bin and the good packs are converged into a single line.

A stand alone system is available for process evaluation in advance of specifying an automatic system.

Alarms can be raised on the above faults and also on SPC data, such as the same pack in the format failing each time – possibly indicating fault location.

Rejected packs remain in high care so can be repacked saving CO2.



*The Jenton Ariana sealtester not only tests for seal vaults but also under gas and over gas.*



## FEATURES

- Tests up to 180 packs per minute
- Will not slow thermoformer down at 15 cycles per minute
- Detects pin holes of typically <0.3mm
- Detects seal faults
- Tests for under and over gas
- Rejects single leaking packs only
- Rejected packs are fed into a lockable bin
- Converges goods for metal detection, checkweighing etc.



## ADVANTAGES

- Large, easy to use colour touch screen
- Recipes of different pack stored for instant setup
- Simple new pack setup
- Easy to maintain including rapid belt change
- Up to IP67 protection

## BENEFITS

- Practically eliminates shipping leaking packs
- Maintains sell by dates
- Will not slow down production line speed
- Removes need for extra converger/singlizer
- Helps maintain optimum pack gas fill
- No need for manual pack testing
- Provides statistical information on pack failure for statistical production monitoring

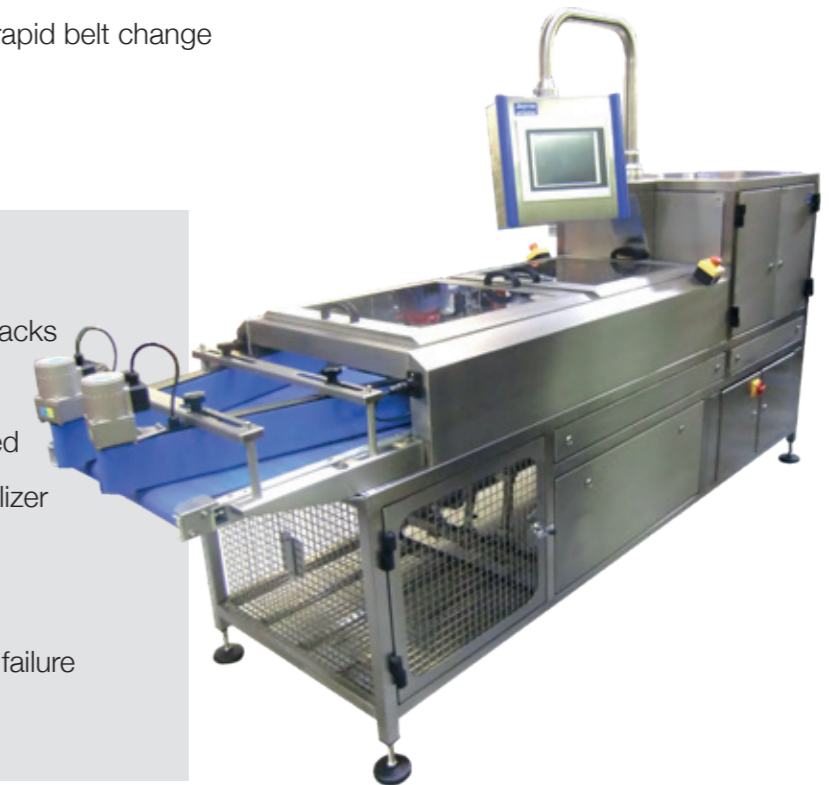



# AUTOMATIC PAD PLACERS FOR TRAY SEALERS & THERMOFORMERS

Jenton Ariana design and manufacture a range of automatic pad placers for both tray sealers and thermoformers. We are able to use either pre-cut pads or cut directly from roll-fed material. Our machines are designed to have as small a footprint as possible and yet are capable of loading up to 180 pads per minute.

## Jenton Ariana 'Autopad' >>>

Our biggest selling machine is the Autopad pad placer for tray sealers using pre-cut pads. The interchangeable pad cassettes make this machine ideal for multi product lines, even when a variety of pads are used. Changeover of cartridges from one size to another takes only a couple of seconds.

## Jenton Ariana Powerslide >>>

The Jenton Ariana Pad Cutter automatically feeds from a roll, cuts and places absorbent 'Peach Pads' into pre-formed trays on a thermoformer or tray sealer up to 150 packs/min. Easily changed between lane configurations and any length of pad. Capable of multi-row and deep pod placing.



## FEATURES >>>

- Operates at approx 20-25 cycles per minute
- Machines are available for pre-cut and roll-fed material
- Pad missing / misfeed alarm
- All stainless steel construction up to IP67

## ADVANTAGES >>>

- Very easy to set up using the colour touchscreen
- Simple connection to try sealer / thermoformer
- Minimum footprint
- Very simple with easy access

## BENEFITS >>>

- Practically eliminates trays without pads
- Most hygienic pad placing eliminates manual pad placing
- 'Fit and forget' operations



# POWERSLIDE

## BENEFITS >>>

- Great cost-reducing potential through the use roll stock instead of ready cut pads.
- Reduced stock of different pad sizes. Extremely easy operation.
- Considerably more hygienic than manual placement
- Significantly lower personnel expenditure
- Roll size to suit production volumes



*The Automatic Pad Placer is without doubt the most efficient way to ensure complete pad placing in trays.*



JenAct

# JENACT

JenAct Limited has been at the forefront of germicidal UV innovation since the 1990s and has a number of granted patents in the field. Our specialisation is the efficient generation of UVC for germicidal applications. JenAct is part of the Jenton Group, manufacturers of automation systems for the food industry and the Jenton team have combined their expertise to develop a range of UV Disinfection Conveyors for the food industry. UV disinfection of pathogens can prevent spoilage, allow longer shelf lives on food products and reduce problems with customers as a result.

JenAct has developed sophisticated modelling software to predict performance and allow optimisation of systems against specific pathogens, including bacteria, viruses and moulds and this will be used for configuration.



*Kills 99.99%  
of airborne  
microorganisms*

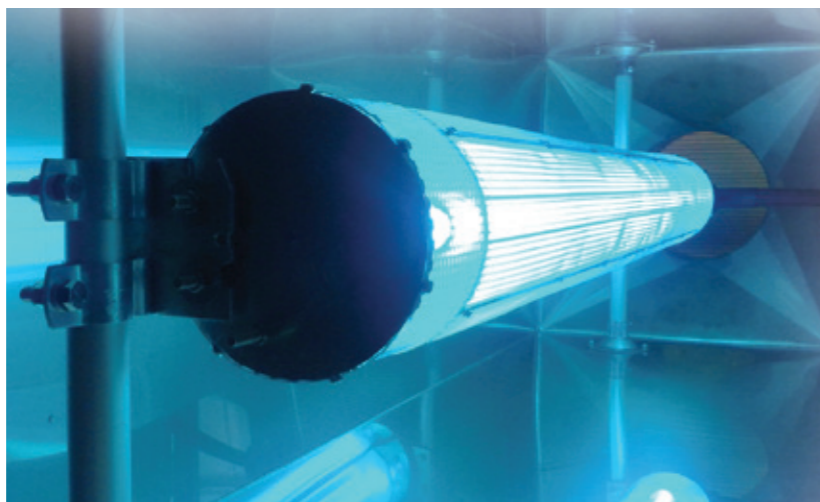

JenAct

# GRU-V AIR PURIFIER COOL / FOOD

GRU-V air purifiers are wall-mounted air disinfection devices manufactured to kill 99.9% of airborne microorganisms thus preventing microbiological contamination of surfaces within the treated areas.

The GRU-V air purifier produces no harmful particles, no biocides, no odours and no harmful chemicals.

It is made from high grade materials with shatter-proof bulbs. The GRU-V is the perfect option for food stores, bakeries, reception areas, offices, medical practice or care facility.

Dramatically decrease the amount of airborne micro-organisms found in your facility by installing the GRU-V air purifier.

## FEATURES & BENEFITS

- High grade food-safe materials with shatter-proof UV lamps
- No ozone, no biocides, no harmful particles or chemicals, no replacement filters
- Easy installation and maintenance
- Low cost spare parts



## EFFECTS OF GRU-V AIR PURIFIER

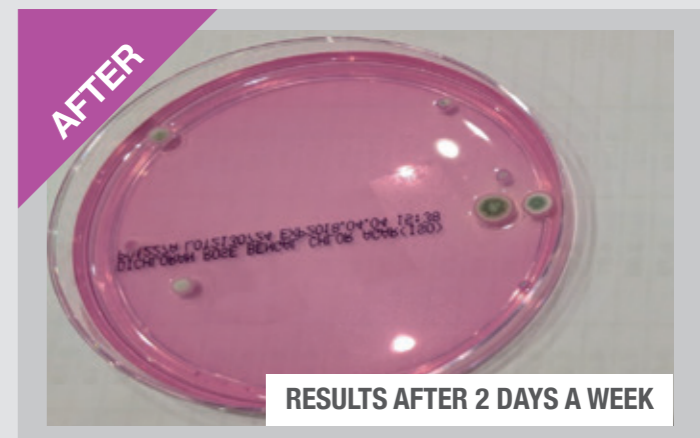

RESULTS AFTER 2 DAYS A WEEK



JenAct

# UV TORPEDO<sup>®</sup> CONVEYOR

JenAct specialises in UV air disinfection and UV surface decontamination using either continuous or pulsed UV systems.

Our bespoke UV disinfection conveyors combine our technical expertise with a scientific approach. We design, manufacture and install the most appropriate UV disinfection conveyors and UV decontamination tunnels in a wide range of applications for prevention or reduction of microbiological contamination.

## FEATURES & BENEFITS

- State-of-the-art UV disinfection modelling software for maximum efficiency
- Bespoke design and customised machines
- IP65 modules for food applications (UKAS certified)
- Performance validated with EIT radiometers
- Easy to clean and maintain
- User friendly interface

*Decontaminates surfaces of packaging and foods*



JenAct

# PULSED UV MUSHROOM CONVEYOR

## Vitamin D enrichment

The pulsed UV mushroom conveyors utilise established vitamin D enrichment process developed by Xenon Corporation. Each machine accommodates a very powerful Xenon pulsed UV system and can be specifically designed to meet your needs. With adjustable guide rails to meet any punnet size, turning your mushrooms into super enriched vitamin D mushrooms could not be easier.

*Vitamin D enriched mushrooms*

## FEATURES & BENEFITS

- Safe and easy operation
- Food-safe (shatterproof) design
- Adjustable process parameters
- Up to 150 packs per minute
- Hassle-free maintenance
- Process validation

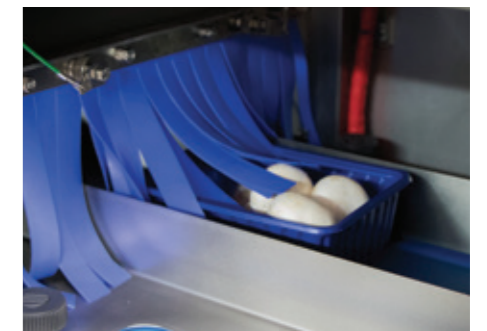





# JENTON DIMACO

## THE POWER OF LABEL VERIFICATION

Label verification is becoming more and more important within the retail packaging world. Having the capability to verify that packaging materials match the products, labels carry the correct 'use by' dates, and allergen information etc. and also the alignment of labels, is helping companies streamline their business, with fewer sleepless nights worrying about possible EPW's, and the resulting wastage, cost and damage to reputations.

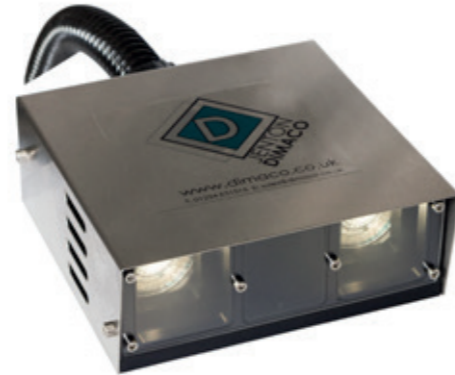

With the high standards and demands from supermarkets, products need to be perfect! Plus, businesses need and want to avoid costly recalls. The number of products in and out of supermarkets is increasing, whereas producers are needing to decrease the amount of time it takes a product to be produced and packed ready for delivery.

**COST SAVING #1**

### NO NEED TO REPLACE LARGE & EXPENSIVE MACHINERY

This is how Jenton Dimaco can help you. The Jenton Dimaco Label Verification system can be installed onto your existing production line. The cameras scan and check the label's data, comparing it to data which is fed to the system from a secure database which has traceability.

*The capability to verify that packaging materials match the products and labels carry the correct 'use by' dates*



**COST SAVING #2**

### INSTALLED TO PREVENT PRODUCT TO PACK MIX UPS

Jenton Dimaco Label Verification checks date, product name, price, weight and more. With Jenton Dimaco reading products into a packing line and verifying that the correct labels are loaded Jenton Dimaco can identify the products arriving at a packing machine and prevent the line from running if the wrong labels are loaded. Not only preventing costly recalls but also preventing expensive repacking.

**COST SAVING #3**

### UTILISE ALIGNMENT INSPECTION SYSTEM TECHNOLOGY

In addition to the Label Verification System, Jenton Dimaco can check label alignment with the Alignment Inspection System. This prevents poor quality labels reaching the supermarket shelves (which is especially important on wine bottles). The system can check labels on the front of round bottles, checking if any are misaligned. Jenton Dimaco also ensures the main body label and neck label match the products filled.

## Veri-CENTRAL

At the heart of all Dimaco systems is Veri-CENTRAL.

Veri-CENTRAL is the active link between the Veri-PACK machines on the production line and the MRP back office system. Veri-CENTRAL checks the production data to ensure that the labelling requirements conform to the COP and then instructs the veri-PACK to check that this has been printed correctly on the correct artwork.

Veri-CENTRAL checks that all data is correct such as country of origin, use by date and price/kg BEFORE its even printed. Once production starts, Veri-CENTRAL logs all key events on every Veri-PACK including production data such as start time, up time, end time as well as critical label verification data such as timed good images and ALL bad images.

This data can be critical in the unfortunate event of a EPW or customer complaint. Furthermore, many supermarkets are now updating their COP so that secure systems such as Veri-CENTRAL can replace time consuming and expensive label check sheets.





# Veri-PACK

Veri-PACK label verification is an online and offline system that improves food safety, quality control and helps avoid costly recalls. Our systems check that the correct labels have been applied to all packs and all essential pre-printed and over-printed data (such as barcodes, dates, prices and weights) are correct and legible. Our systems provides archives and enhanced traceability to make checking back for changes easy.



*Now available with X-Ray / Check Weighing / Metal Detection in a single short machine.*

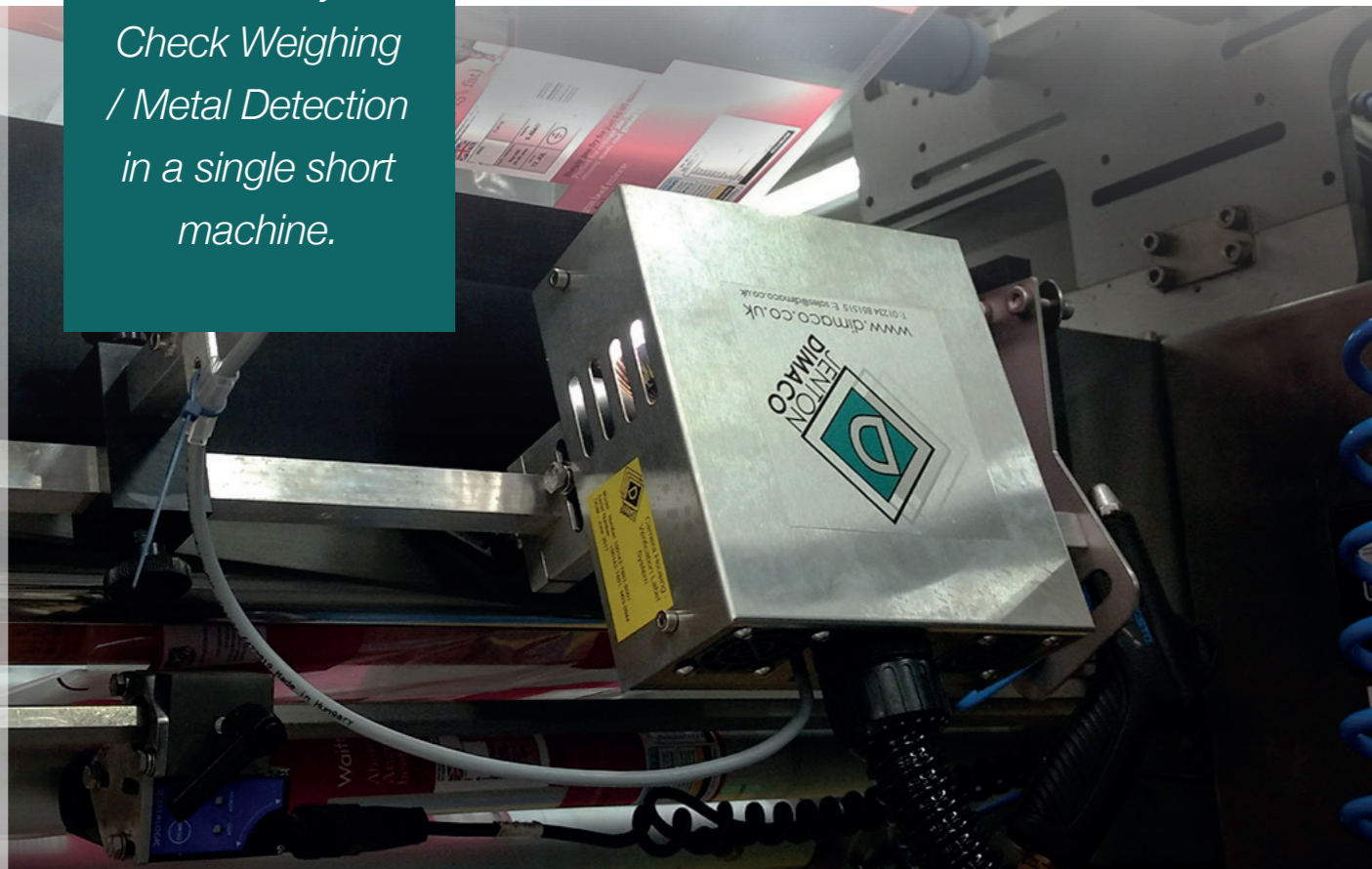

## ONLINE - VERIFIES

- Label Placement
- Label Identification
- Checks hand applied labels
- Over printed data
- Over printed barcode
- Promotional labels



## ONLINE - BENEFITS

- Avoids label mix-up
- Ensures data is correct and legible
- Reduces risk of product recall
- Significant QA labour savings
- Eliminates factory produced paperwork
- Prevents poor quality barcodes reaching the checkout
- No costly barcodes required on promo labels
- No expensive printer interfaces
- Catch weight check independent of weigh price labeller
- Option to save all inspection images (ultimate traceability)
- Interfaces into production management system

## OFFLINE - VERIFIES

- Pack presence
- Label Placement
- Label Identification
- Checks hand applied labels
- Over printed data
- Over printed barcode
- Promotional labels
- Optional integrated check -weighing

## OFFLINE - BENEFITS

- Avoids label mix-up
- Ensures data is correct and legible
- Reduces risk of product recall / EPW
- Significant QA labour savings
- Eliminates factory produced paperwork
- Prevents poor quality barcodes reaching the checkout
- Electronically archives inspection results



# Veri-WEIGH

Veri-WEIGH online system improves food safety as well as product traceability. The system is a combined checkweigher and label verifier. Not only does it carry out all standard checkweigher functions such as pack weight, average weight and % give away but it also checks that the correct labels have been applied to all the packs. All essential pre-printed and over-printed data, such as barcode, dates, price and weight, are verified to be correct and legible. In addition all user changes to the system are achieved, providing enhanced traceability.



*Improving  
food safety  
and product  
traceability*



## BENEFITS

- Extremely space and cost effective
- Avoids label mix ups
- Ensures the data is correct and legible
- Reduces risk of product recall
- Significant QA labour savings
- Eliminates factory produced paperwork
- Prevents poor quality barcodes reaching checkouts
- Electronically archives inspection results
- No costly barcodes required on promo labels
- No expensive printer interfaces
- Catch weight check independent of weigh price labeller
- Option to save all inspection images
- Interfaces into production management systems



## LABEL VERIFICATION

- Label Placement
- Label Identification
- Checks hand applied labels
- Over-printed data
- Over-printed barcode
- Promotional Labels

## CHECKWEIGHER

- Pack weight
- Average weight
- Min and Max weight
- % Give away
- Meet average weight legislation
- Servo feedback control
- Up to 5 weight rejects



# JENTON GROUP

SINCE 1973

Specialising in the supply and support of products for the following industries:

## Packaging

## UV Curing and Converting

## UV Disinfection

## Software

We offer design and consultancy services in addition to machinery sales and have fully equipped service, workshop, laboratory and demonstration facilities.

## Packaging

- Jenton Ariana** - Food Packaging Automation
- ATS** - Ultrasonic Seal Banding Machine
- Jenton Bandit®** - Heat Seal Banding Machines
- Pleckpack Emplex** - Bag Sealers - Food and other industries
- Controls Engineering LLC** - Stretch Film Banders
- Jenton Dimaco** - Label and Data Verification

## UV Curing and Converting

- Excelitas (formerly Lumen Dynamics)** - UV Spot Curing and LED Curing Equipment
- EMI** - UV Cured Adhesives, Epoxies and Coatings
- EIT** - UV Radiometers
- Jenton UV** - Modular UV Curing Lamps and Power Supplies
- opti-color** Ink Control Systems
- Jenton UV Conveyors** - Laboratory and Production Conveyors

## UV Disinfection

- JenAct UV** - UV Disinfection, UV Surface Sterilisation and Microwave UV Technology
- Xenon** - UV Based Vitamin Enhancement

## Software

- Expidero** - Custom Software

Founder Member



[www.jenton.co.uk](http://www.jenton.co.uk)



**[www.jenton.co.uk](http://www.jenton.co.uk)**

**01256 892194 ∴ [sales@jenton.co.uk](mailto:sales@jenton.co.uk)**

Unit 9/10 Ardglen Industrial Estate, Whitchurch, Hampshire RG28 7BB