

Rehab

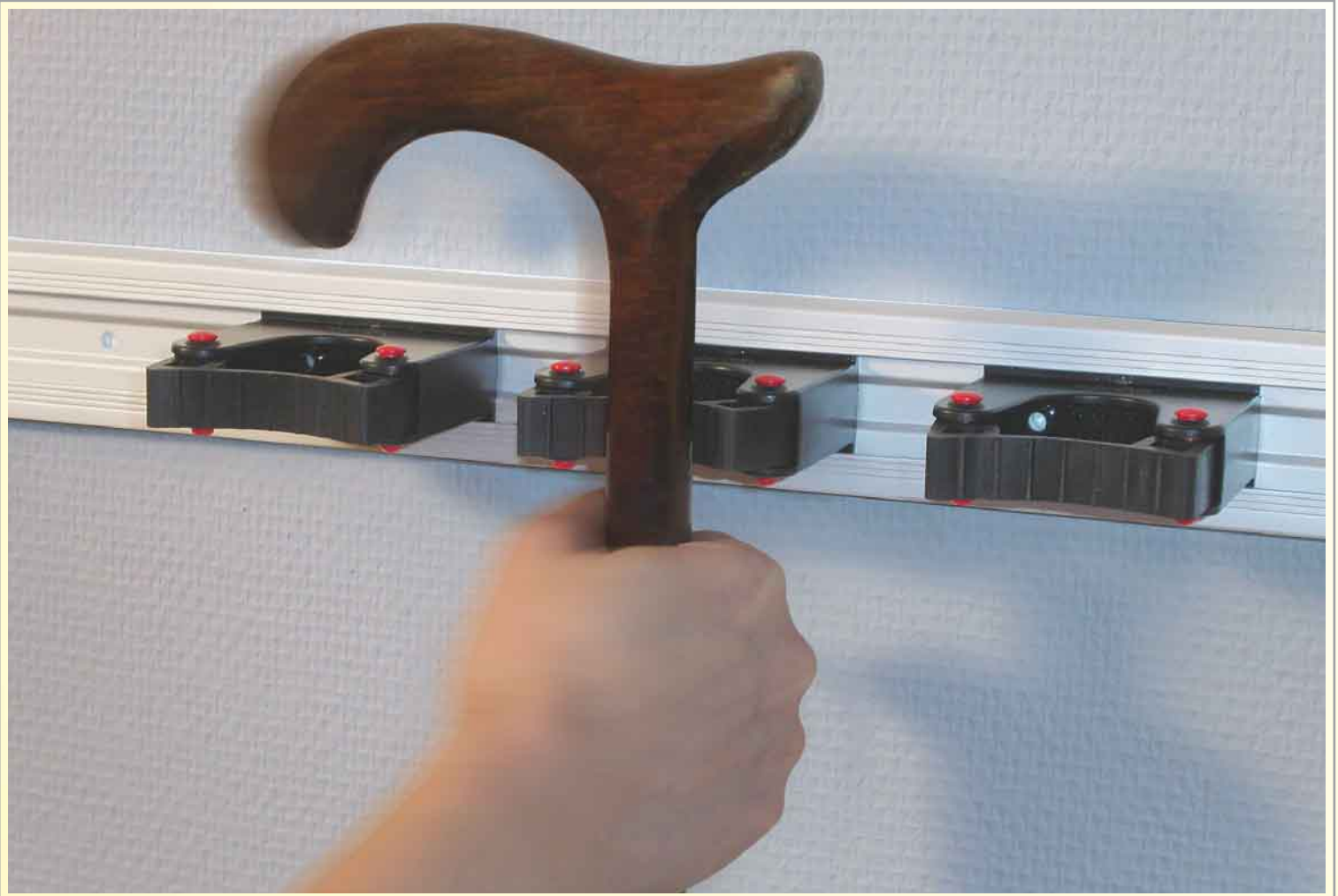

SYSTEM **toolflex**®
SYSTEM TOOLFLEX ORIGINAL • MADE IN SWEDEN



System Toolflex

– Swedish ingenuity when you have to let things go



System Toolflex is a series of tool holders that make everyday living easier for people with decreased mobility.

The gripper is made from flexible EPDM rubber that grasps the assisting equipment with a simple push of the hand.

Assistance equipment and tools stay safely in place and within easy reach with System Toolflex.



TOOLFLEX on a rack – ideal for storing several items all in one place.

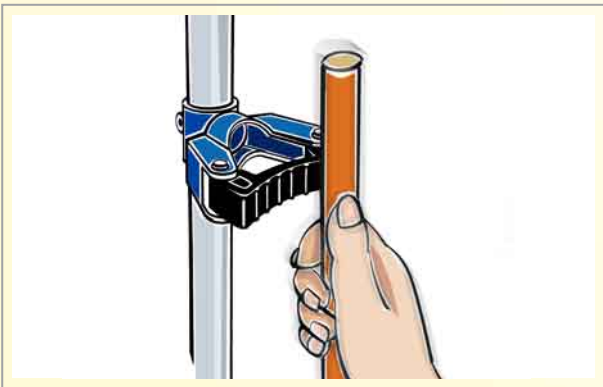

Simple to use, all it takes is a simple push of the hand.

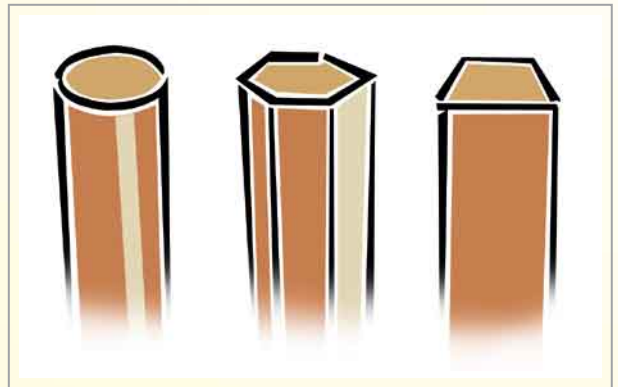

Holds different shaped handles with a firm grip.



Withstands heavy weights and vibrations.

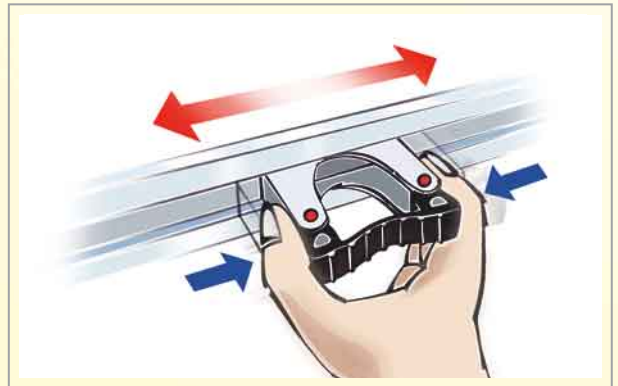

Toolflex on a rack – easily adjustable sideways and can be added to as needed.

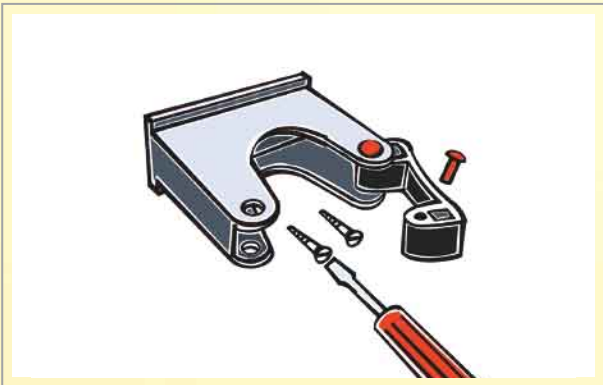

The holders are pre-designed to be mounted directly on the wall.

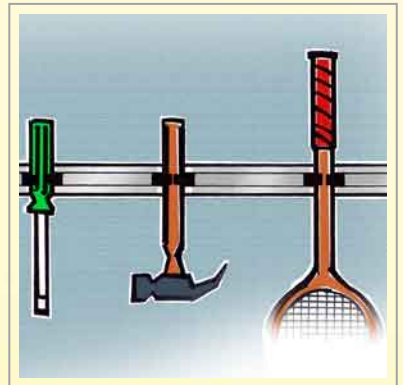
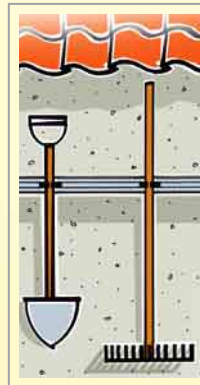

Works just as well indoors as outdoors.

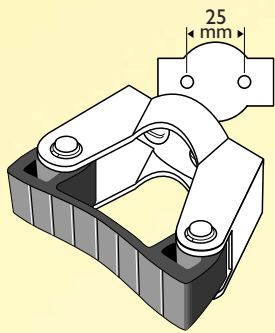

530-I

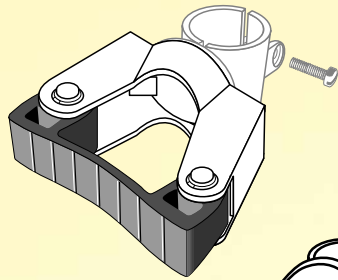

535-I



540-I

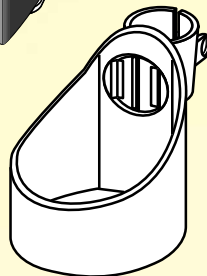

590-I

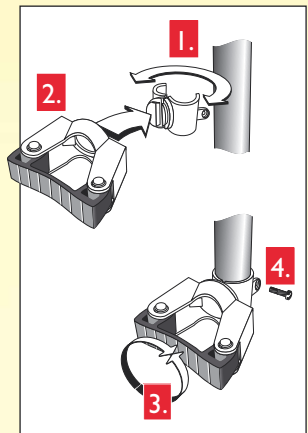

TOOLFLEX 530 is intended for mounting on a flat surface.
 TOOLFLEX 535, with the same design, is intended for mounting on tubes.
 The size of the tube determines the size of the tube clamp.
 Tube Clamp 540 is available in diameters of 17-30 mm.
 A number -I after the model number indicates the standard color black.
 Also available in other colors.

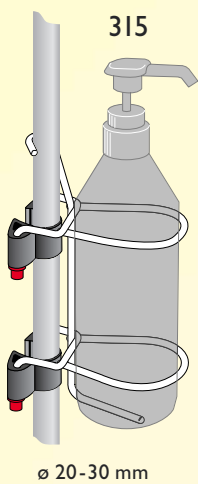

315

∅ 20-30 mm

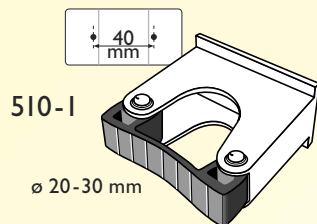

510-I

∅ 20-30 mm

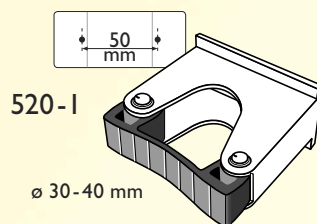

520-I

∅ 30-40 mm

556-I

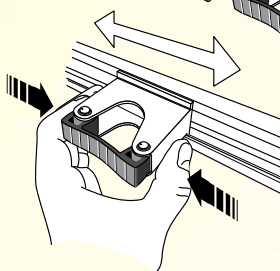

555-I

50 cm. 550-I

90 cm. 551-I

Holder 510 for handles with 20–30 mm diameters.
 Holder 520 for handles with 30–40 mm diameters.
 Aluminum racks 550 and 551 are available in two standard lengths.
 Racks 555 and 556 include holders.
 More holders can be added as necessary.